

HINDMOTOR HIGH SCHOOL

WORK SHEET

Class - 1

HINDMOTOR HIGH SCHOOL

Worksheet 3

Subject - Computer

Class -1

A computer is a device or machine for working with information. The information can be numbers, words, pictures, movies or sounds. Computer information is also called data. Computers can process huge amounts of data very quickly. Charles Babbage invented modern computer. Computers are used in offices, schools colleges, shops and different ticket booking counters also.

Worksheet

1) Recognize the picture and write the names of its parts-

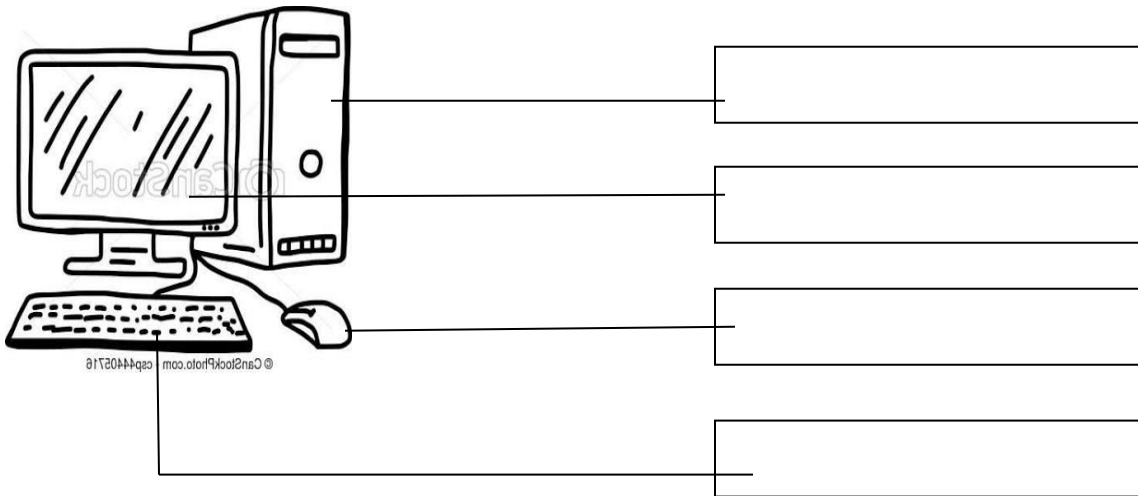

2) Rewrite the following letters correctly to make meaningful words:

- a) TELHO ----- b) CEOFFO ----- c) MESAG ----- d) TIONSTA -----

3) Answer in one word :

- a) We can play this in computer -----
b) To start the computer first step is to we have to switch on this-----
c) The full form of UPS -----
d) This supplies electricity to the computer when the power is gone -----

HINDMOTOR HIGH SCHOOL

Worksheet 3

Subject - English Language

Class - 1

One and more than one

There are two numbers in English Grammer, The Singular (One) and the Plural (More than one or many) .

Read the following words:

One	Many
Pen	Pens
Balloon	Balloons

The first word of each pair refers to one thing. The second word of each pair refers to more than one thing. The Noun is Singular when it refers to one thing. And The Noun is Plural when it refers to more than one thing.

1) Forming Plurals by adding 's'

Flower – Flowers Book - Books

Train – Trains Tree - Trees





2) Forming Plurals by adding 'es'

Box -- Boxes Dish –Dishes

Bus -- Buses Bunch – Bunches

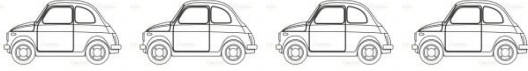
WORKSHEET ---3

1) Look at the pictures and fill in the blanks by adding 's' to the Naming words:

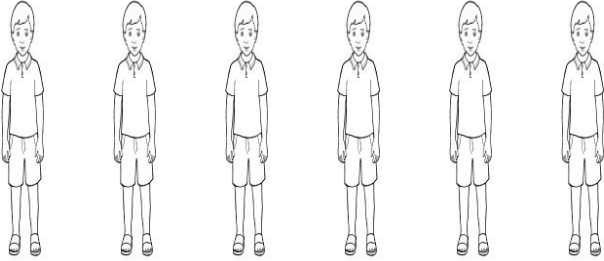
One	Many
 One car	 Four _____
 One rose	 Five _____
 One Boy	 Six _____

2) Write the nouns given in the box in the correct column:

a) horses, b) toy, c) months, d) rat, e) chairs, f) hand g) balls
h) books i) flower, j) brother k) trees l) doll m) glasses n) girls

One	Many

3) Look at the pictures and circle the right words :

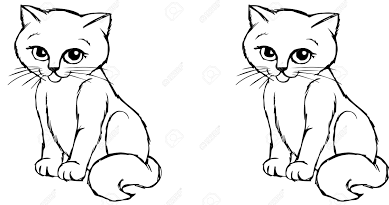

a) **Cat Cats**



b) **Dog Dogs**



c) **Rat Rats**

HINDMOTOR HIGH SCHOOL

Worksheet 3

Subject - English Literature

Class -1

A Happy Child (poem)

Here in this poem, the poet Kate Greenaway is talking about a child. The child is having a little red house. He laughs and plays the whole day and hardly ever cry. He has a green tree to give him shade from the sun. He often sits under it when all his work is done. Sometimes he takes a basket and goes to the town to buy some cake.

Worksheet -3

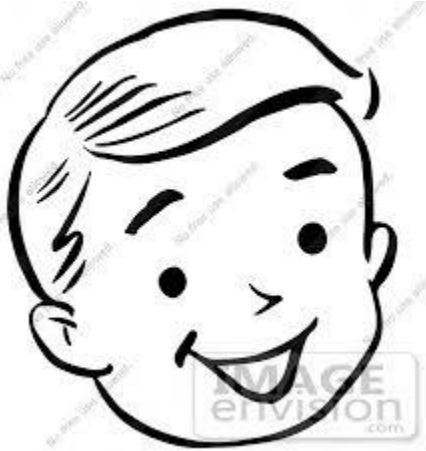

- 1) Look at the picture and recognize the poem
and Fill in the blanks with the correct words:

My house is _____ a little house,

A _____ child am I,

I laugh and play the _____ day,

I _____ ever cry.

2) Write the synonyms of:

- a) little ---- _____
b) Happy ---- _____

3) Write the antonyms of:

- a) Little ----- _____
b) Happy ----- _____
c) Laugh ----- _____
d) under ----- _____

4) Make sentences with:

- a) House ----
b) Basket -----

5) Write the Rhyming words of :

- a) House ---- _____
b) Sun ----- _____

HINDMOTOR HIGH SCHOOL
Worksheet 3
Subject - Environmental Studies
Class – 1

My Body

In this chapter we will learn about human body parts. Without head we cannot. See, hear, smell or eat. It has ears with which we hear different sounds. It has eyes with which we see different things around us and it has nose which smells different types of aroma. We taste sweet, salty and spicy things with our tongue and feel heat and cold with our skin. Brain is the engine of our body. It controls all the other body parts. We have two arms to hold and lift things .We have two hands and ten fingers for clapping and holding. We have two legs for walking, jumping, dancing and cycling.

Worksheet – 3

1) Rearrange the following letters to make meaningful words:

- a) INARB ---- _____ b) ENIGEN ----- _____
c) NDOUAR ----- _____ d) GUETON ----- _____

2) Who am I ?

- a) I am a bag that you can carry when you travel --- _____
b) I am the sense organ to smell --- _____

3) Complete the following:

- a) My head is covered with _____.
b) We see different persons _____.
c) I use my hands for _____.

4) Recognize the body parts and write how do they help us?



a)

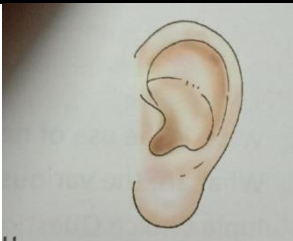

b)

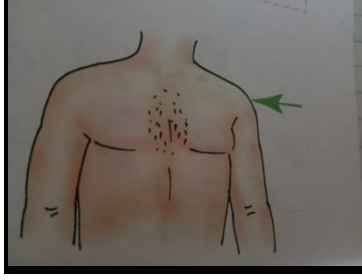

c)

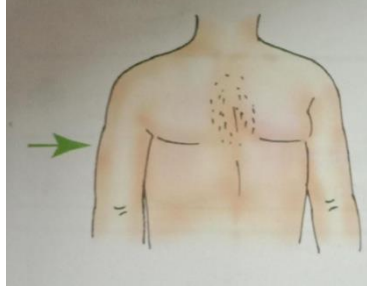

d)

HINDMOTOR HIGH SCHOOL

Worksheet 3

Subject - HINDI

सारांश:

शब्द :

दो या दो से अधिक अक्षरों के मेल से बने सार्थक ध्वनि को शब्द कहते हैं।

जैसे कल, कनक, भवन, कसरत आदि।

दो अक्षरों के मेल से बने सार्थक ध्वनि को दो अक्षर वाले शब्द कहते हैं। जैसे- खग, कब, वन आदि।

तीन अक्षरों के मेल से बने सार्थक ध्वनि को तीन अक्षर वाले शब्द कहते हैं। जैसे- खबर, चरण, भवन आदि।

• जोड़कर शब्दों को लिखें।

ध + न = _____

र + स = _____

ख + त = _____

भ + व + न = _____

म + ग + र = _____

श + ह + द = _____

• तीन अक्षर वाले शब्दों को गोला करें।

जगत	वन	मटर	बरगद
टब	नयन	जगत	कमल
गदगद	मग	खत	नहर
छत	सड़क	रबड़	दल

HINDMOTOR HIGH SCHOOL



Worksheet 3

Subject - Mathematics

Class - 1

Numbers upto 10

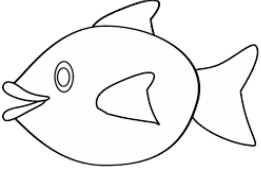
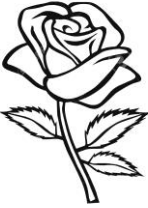
1) Fill in the missing ordinal numbers. Then fill in the blanks using the pictures provided:

			
First		Third	

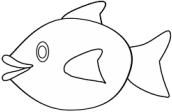
a) The  is in the _____ position.

b) The  is in the _____ position.

c) The  is in the _____ position.

d) The  is in the _____ position.

2) Colour the following pictures as directed:

- a) First Red
Fifth Yellow

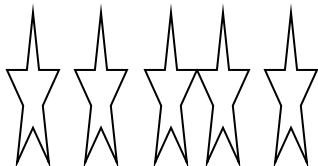

b) Third Green
Sixth Purple

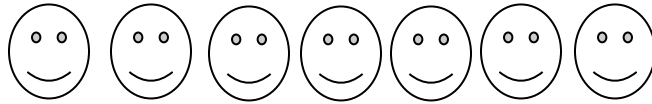

c) Second Blue
Fourth Orange

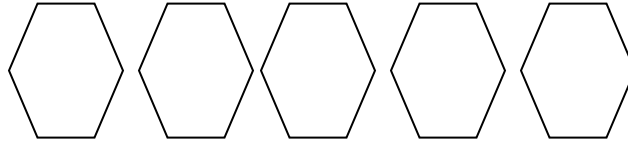

3) Subtract and Write:

a) $7 - 4 =$ _____ b) $8 - 0 =$ _____ c) $9 - 3 =$ _____

d)
$$\begin{array}{r} 5 \\ - 2 \\ \hline \end{array}$$
 e)
$$\begin{array}{r} 6 \\ - 1 \\ \hline \end{array}$$
 f)
$$\begin{array}{r} 4 \\ - 0 \\ \hline \end{array}$$

4) Put the correct sign < or > or =

a) 6 _____ 4 b) 2 _____ 9 c) 7 _____ 7

Hind Motor High School
Class- I
Sub- Bengali
Worksheet – 3 (2020-21)
পাথ- ১ (খোকা চোখ মেলো রে)

খোকা সোনা ভোর হয় গেছে দরজা খোলো। ঘুম থেকে जागো, আলো ফুটে গেছে, ফুল ফুটেছে
চোখ মেলে দেখ । খোকা গাছের ডালে পাখি ডাকছে হাঙ্কা বাতাস বইছে। ফুলের বনে আলিকল
মধুর লোভে ছুটে বেড়াচ্ছে, খোকা একবার চোখ খুলে দেখরে।

1. ফাঁকা জায়গায় ঠিক কথাটি বসাতো :-

পাখি ডাকে তবু _____
মৃদু _____ বহরে
ফুল বনে _____
মধু _____ ছোটে রে

2. মানে লেখ :-

তরু-
মৃদু-
অলি-
দোর-

3. নীচের দেওয়া লাইন গুলির পরের লাইন টি লেখ :-

ফুল বনে অলি কুল _____
এইবার এইবার _____
পাখি ডাকে তবু শাখে _____
ভোড় হল দোর খোলো _____